



威柏电子提供变频器核心功率器件



標準形 (0.5kW以下) EMCフィルター一体形 (1.5kW以下) 数値形 (IP54) (7.5~90kW)

INVERTER DRIVE OVP/OCP

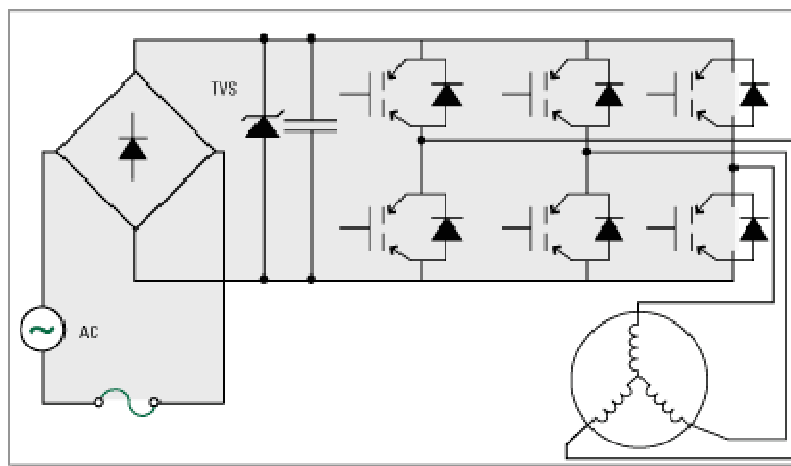

FE Fuji Electric 富士电机IGBT/IPM中国区一级代理-威柏电子

香港威柏
(852)2763 5991
(852)2343 6979

深圳威柏
0755-8826 7606
0755-8826 7406

上海威柏
021-5489 1460
021-5425 9682

北京威柏
010-6750 6489
010-6750 6489

青岛威柏
0532-8823 1566
0532-8580 7948

成都威柏
028-8554 0368
028-8554 0368



威柏电子通用变频器解决方案



平波用铝电容，薄膜电容

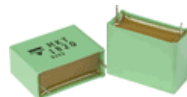

FUJI IGBT/IPM模块

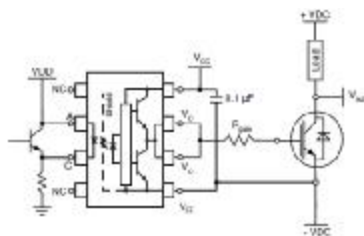
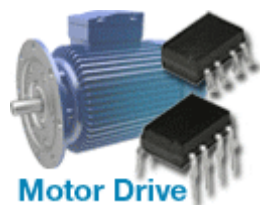
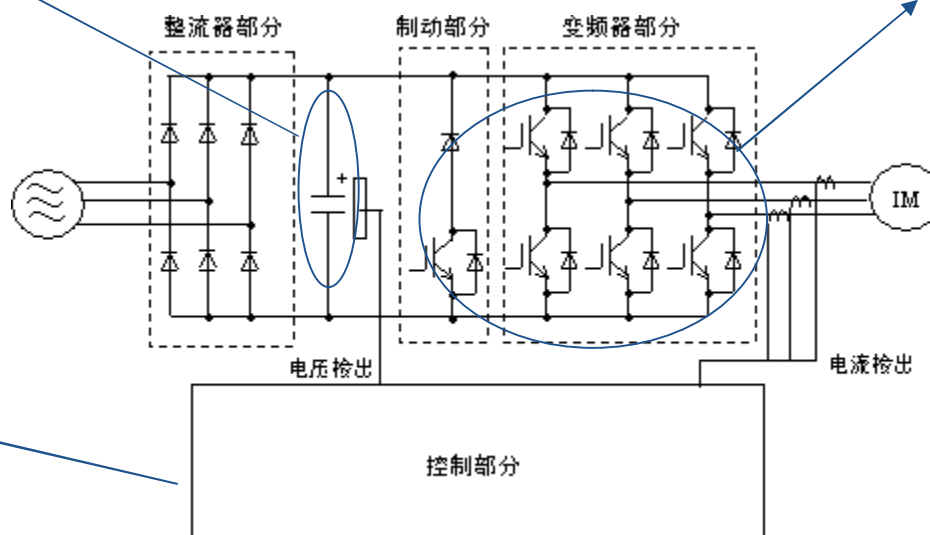

IGBT驱动(VO3120); 高速光耦; 线性光耦



小功率变频解决方案



富士单管IGBT



P/N (preliminary)	VCE	IC	Package
FGW30N60HD	600V	30A	TO-247
FGW50N60HD	600V	50A	TO-247
FGW75N60HD	600V	75A	TO-247
FGW30N60H	600V	30A	TO-247
FGW50N60H	600V	30A	TO-247
FGW75N60H	600V	30A	TO-247

P/N (preliminary)	VCE	IC	Package	Note
FGW15N120HD	1200V	15A	TO-247	Ultra fast FWD
FGW25N120HD	1200V	25A	TO-247	Ultra fast FWD
FGW40N120HD	1200V	40A	TO-247	Ultra fast FWD
FGW15N120H	1200V	15A	TO-247	w/o FWD
FGW25N120H	1200V	25A	TO-247	w/o FWD
FGW40N120H	1200V	40A	TO-247	w/o FWD

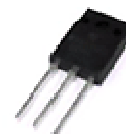



小功率变频解决方案



富士PIM模块 富士6单元模块



适配电机功率 (KW)	S系列	U系列	V系列
0.75	7MBR10SA-120		
1.5	7MBR10SA-120		
2.2	7MBR15SA-120		
3.7	7MBR25SA-120		7MBR25VA-120
5.5		7MBR50UA-120	7MBR35VA-120
7.5	7MBR50SB-120	7MBR75U4B-120	7MBR50VB-120
11	7MBR50SB-120	7MBR75U4B-120	7MBR50VB-120
15		7MBR100U4B-120	7MBR75VB-120
18.5		6MBI 100U4B-120	6MBI 100VB-120
22		6MBI 100U4B-120	6MBI 100VB-120
30		6MBI 150U4B-120	6MBI 150VB-120



6MBI100VB-120-50

IGBT Modules

IGBT MODULE (V series)
1200V / 100A / 6 in one package

■ Features

- Compact Package
- P.C.Board Mount
- Low $V_{CE(sat)}$

■ Applications

- Inverter for Motor Drive
- AC and DC Servo Drive Amplifier
- Uninterruptible Power Supply
- Industrial machines, such as welding machines

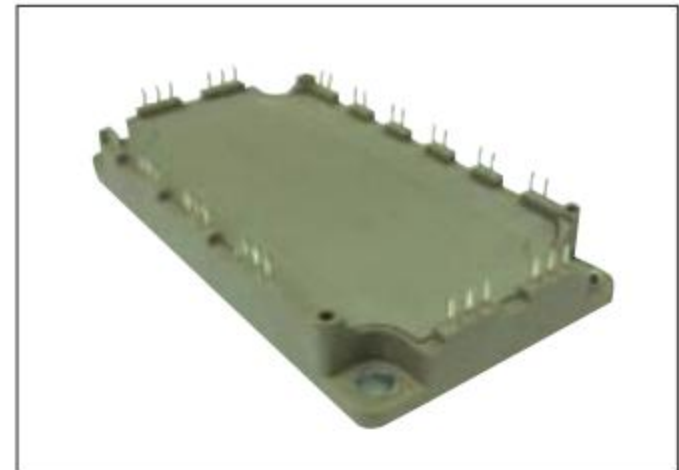



6MBI150VB-120-50

IGBT Modules

IGBT MODULE (V series)
1200V / 150A / 6 in one package

■ Features

- Compact Package
- P.C.Board Mount
- Low $V_{CE(sat)}$

■ Applications

- Inverter for Motor Drive
- AC and DC Servo Drive Amplifier
- Uninterruptible Power Supply
- Industrial machines, such as welding machines

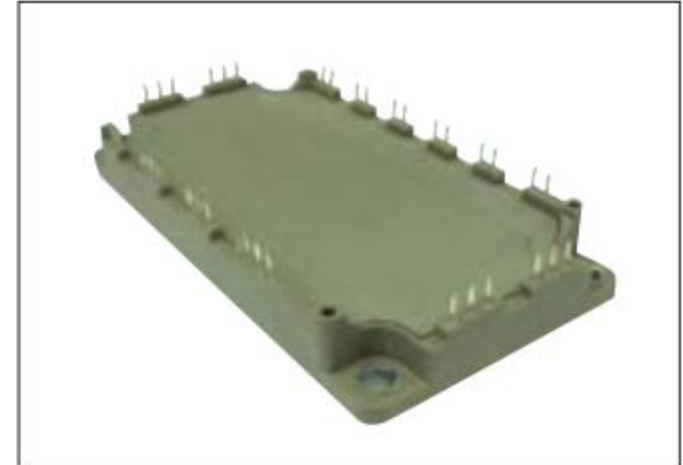



中大功率变频解决方案



适配电机功率(KW)	U系列	V系列
37	2MBI 150U4H-120*3	
45	2MBI 200U4H-120*3	2MBI 200VH-120*3
55	2MBI 300U4H-120*3	2MBI 300VH-120*3
75	2MBI 300U4N-120*3	2MBI 300VN-120*3
75	2MBI 400U4H-120*3	2MBI 450VH-120*3
90	2MBI 400U4H-120*3	2MBI 450VH-120*3
110	2MBI 450U4N-120*3	2MBI 450VN-120*3
132	2MBI 300U4N-120*6	2MBI 300VN-120*6
132	2MBI 300U4H-120*6	2MBI 300VH-120*6
160	2MBI 300U4H-120*6	2MBI 300VH-120*6
160	2MBI 300U4N-120*6	2MBI 300VN-120*6
180	2MBI 300U4H-120*6	2MBI 300VH-120*6
180	2MBI 300U4N-120*6	2MBI 300VN-120*6
200	2MBI 300U4H-120*9	2MBI 300VH-120*9
200	2MBI 450U4N-120*6	2MBI 450VN-120*6
250	2MBI 300U4N-120*9	2MBI 300VN-120*9
250	2MBI 400U4H-120*9	2MBI 450VH-120*9
280	2MBI 300U4N-120*9	2MBI 300VN-120*9
280	2MBI 400U4H-120*9	2MBI 450VH-120*9
315	2MBI 400U4H-120*12	2MBI 450VH-120*12
355	2MBI 400U4H-120*12	2MBI 450VH-120*12
400	2MBI 450U4N-120*9	2MBI 450VN-120*9



2MBI450VN-120-50

IGBT Modules

IGBT MODULE (V series)
1200V / 450A / 2 in one package

■ Features

- High speed switching
- Voltage drive
- Low Inductance module structure

■ Applications

- Inverter for Motor Drive
- AC and DC Servo Drive Amplifier
- Uninterruptible Power Supply
- Industrial machines, such as Welding machines





<http://www.fujisemi.com>

6MBI450V-120-50

IGBT Modules

IGBT MODULE (V series)

1200V / 450A / 6 in one package

■ Features

- Compact Package
- P.C.Board Mount
- Low $V_{CE(sat)}$

■ Applications

- Inverter for Motor Drive
- AC and DC Servo Drive Amplifier
- Uninterruptible Power Supply
- Industrial machines, such as welding machines

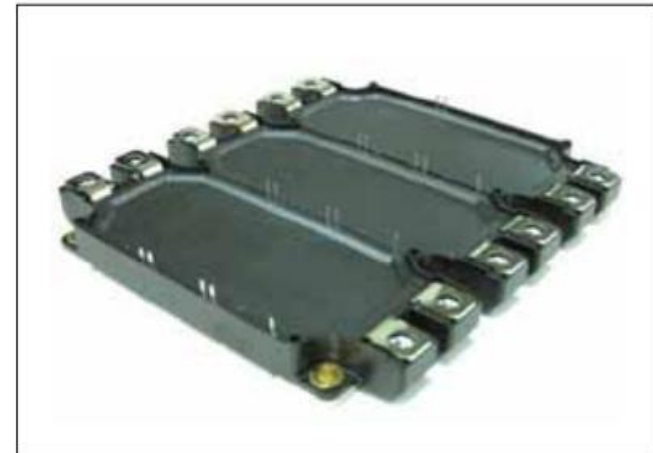



部分中压变频专用模块

风机水泵专用高压变频器

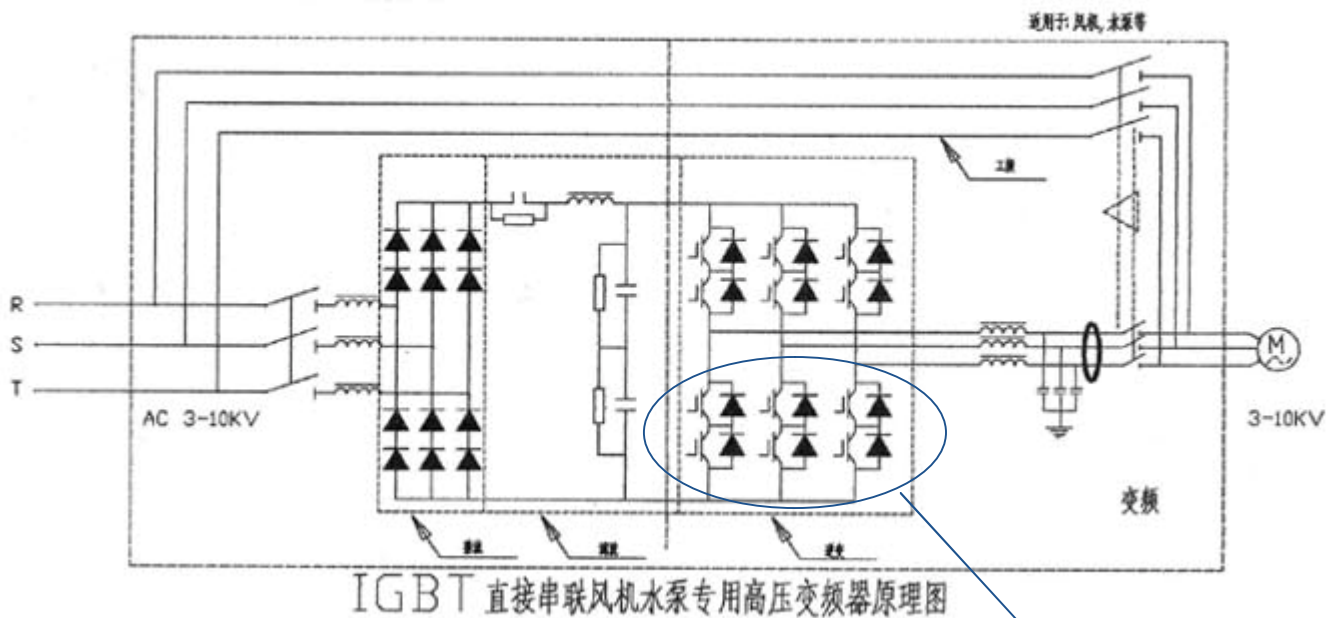

6MBI450U-170

采用U芯片，成熟可靠，成本最优！





6MBI450U-170



IGBT Module U-Series 1700V / 450A 6 in one-package

■ Features

- Compact Package
- P.C.Board Mount
- LOW $V_{CE(sat)}$

■ Applications

- Inverter for Motor Drive
- AC and DC Servo Drive Amplifier
- Uninterruptible Power Supply
- Industrial machines, such as welding machines





大功率低压变频专用模块

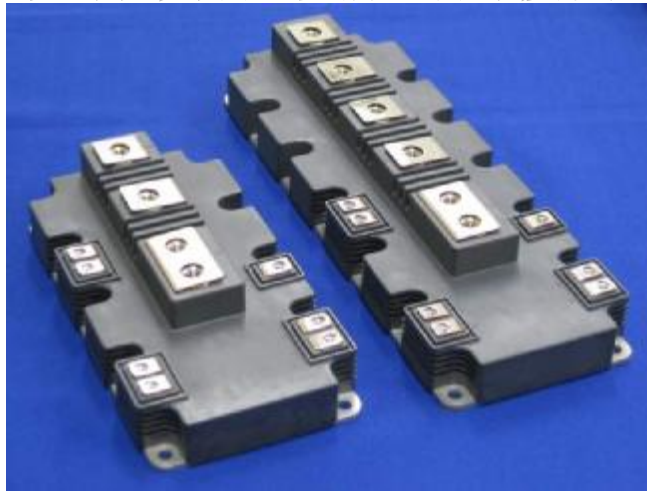

1200V-600A 兼容PrimePack2(FF600R12IE4) : 2MBI600VXA-120E-50
1200V-900A 兼容PrimePack2(FF900R12IP4) : 2MBI900VXA-120P-50
1200V-1400A 兼容PrimePack3(FF1400R12IP4) : 2MBI1400VXB-120P-50

1700V-650A 兼容PrimePack2(FF650R17IE4) : 2MBI650VXA-170E-50
1700V-1000A 兼容PrimePack3(FF1000R17IE4) : 2MBI1000VXB-170E-50
1700V-1400A 兼容PrimePack3(FF1400R17IP4) : 2MBI1400VXB-170P-50



优良的热特性：

$T_j(\text{op})=150^{\circ}\text{C}$, $T_j(\text{max})=175^{\circ}\text{C}$

低损耗, 最新一代的V系列芯片 (大功率版)
低 V_{on} , 低浪涌电压, 软关断特性

低热阻

长温度循环寿命

应用设计简易：

NTC 内置

符合RoHS

低寄生电感

缩减系统体积

易寻找替代产品

可与IFX4可共用驱动板

1200V 600A,900A in PP2

1200V 1400A and 1700V-1000A in PP3

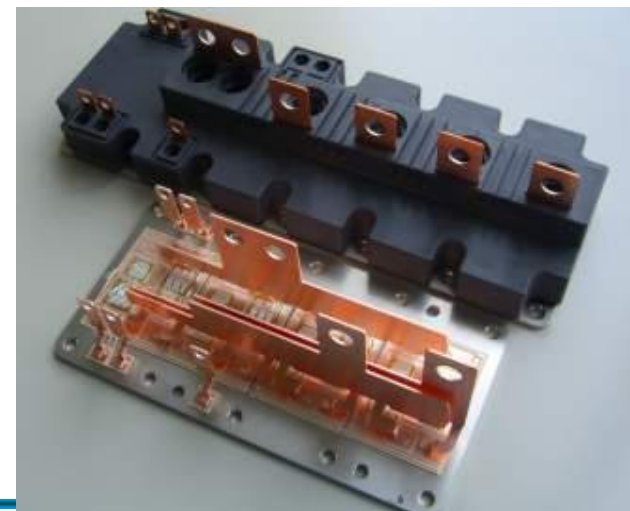

Westpac Electronics Limited
威柏電子有限公司

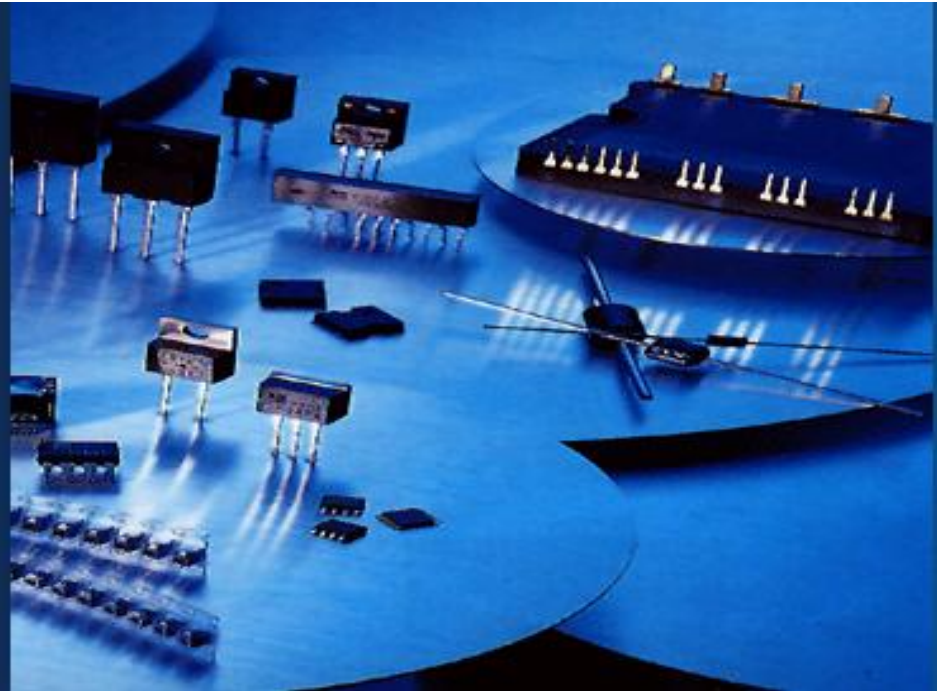

威柏電子有限公司

Westpac深圳分公司:

深圳市威柏德电子有限公司

深圳: 深圳市福田区金田路诺德中心17楼B室

Nobel Center 17B Room, JinTian Road, Futian District

电话: 0755-88267606 88262913 88262982 88262986 传真: 0755-88267406